

Nanodyne Replacement Illuminator for Nikon 80i Installation Instructions- Included Items

Additional Items Included But Not Shown:

- PN 10456 Hex Key 1.5mm (for pot knob)
- PN 10337 Hex Key 2mm Short Arm (for set screw)

Needed but not included:

- 12mm socket to remove original pot
- 7/16 socket to install new pot

IMPORTANT NOTE - If the hole for the potentiometer is less than 9mm diameter you need to drill it out with a 9mm or 23/64 drill to fit the custom nut.

The illuminator may be powered by plugging the cable into the power supply provided, or into a suitable USB port on a computer or other device.



PN 11163 Power Supply 5V 2.1A and PN 10734 Power Cable 1.35mm ID/3.5mm OD x USB A 6 ft.

Power supplies are subject to substitution without notice due to availability issues and changes in regulations.

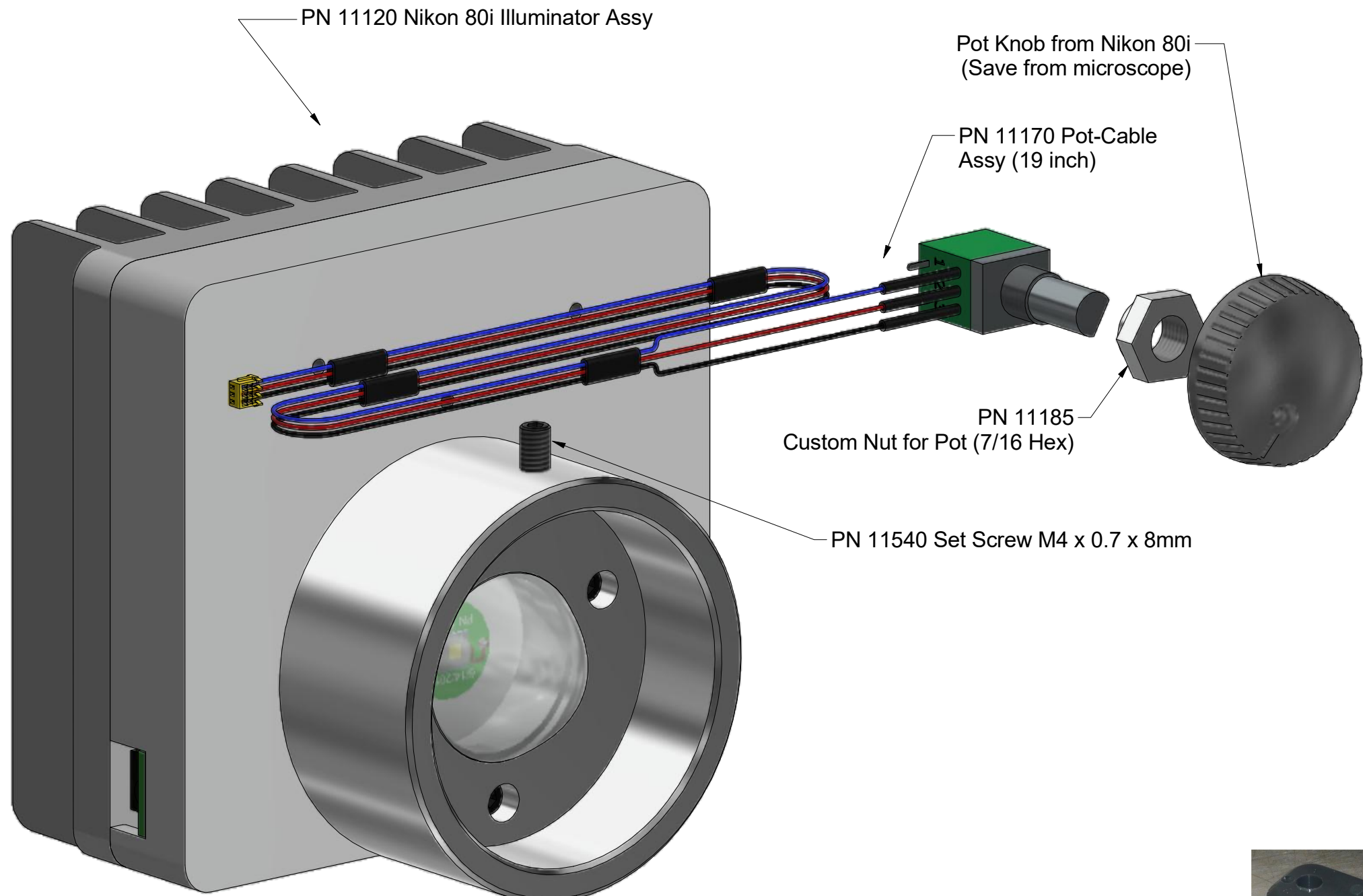

PN 10736 Rubber plug to block unused AC power receptacle.



3M VHB tape to secure pot cable

Han-Seung Yang	5/19/2021	
PN 11121 Nikon 80i Illuminator System Installation Instructions	REV 4	
SHEET 1 OF 7		

Nanodyne Replacement Illuminator for Nikon 80i Installation Instructions: Step 1. Remove Old Illuminator, Bottom Cover and Old Adjustment Pot



(1) Be sure the AC power is unplugged. Disconnect the original lamp power cable.



(2) Loosen the set screw holding the original lamp.



(3) Remove the original lamp.

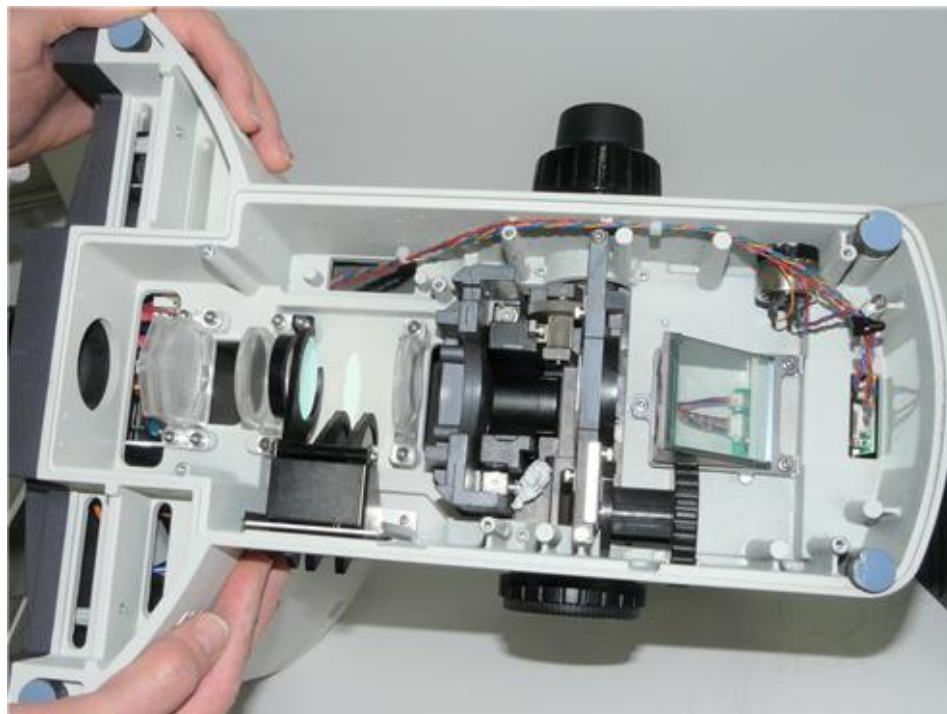

(4) Remove bottom cover.

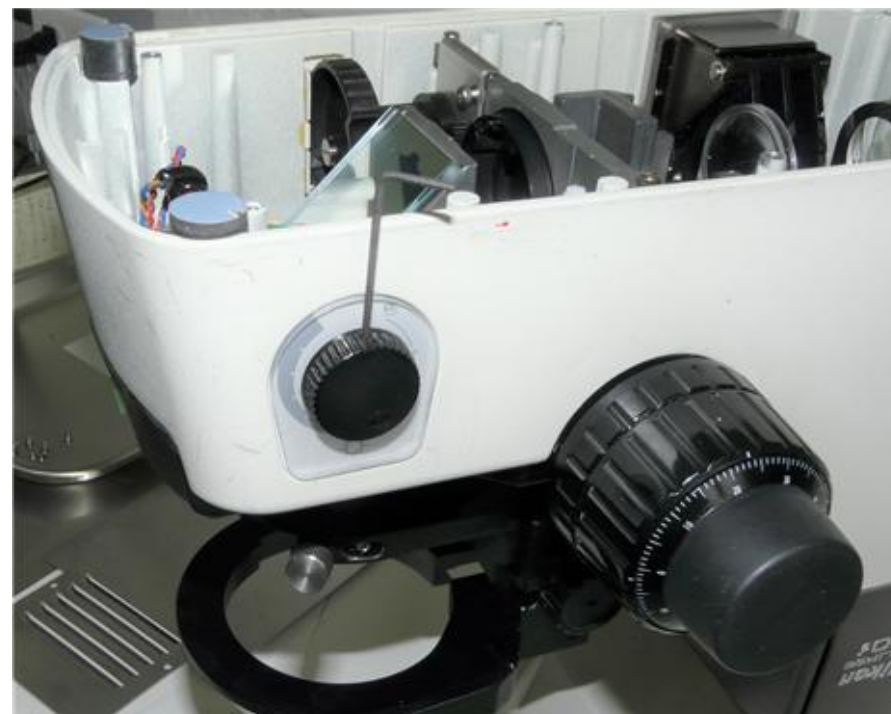

(5) Remove the knob using the 1.5mm hex key. Save the knob for the new pot.



(6) Remove the nut holding the old pot, using a 12mm socket.

Nanodyne Replacement Illuminator for Nikon 80i Installation Instructions: Step 2. Remove Back Cover and Old Pot Wiring



(1) The control on the front of the microscope will be obsolete. Intensity control for the new illuminator will only use the knob on the left.



(3) Remove the back cover. It is held by 8 socket head screws. Use a hex key to remove them.

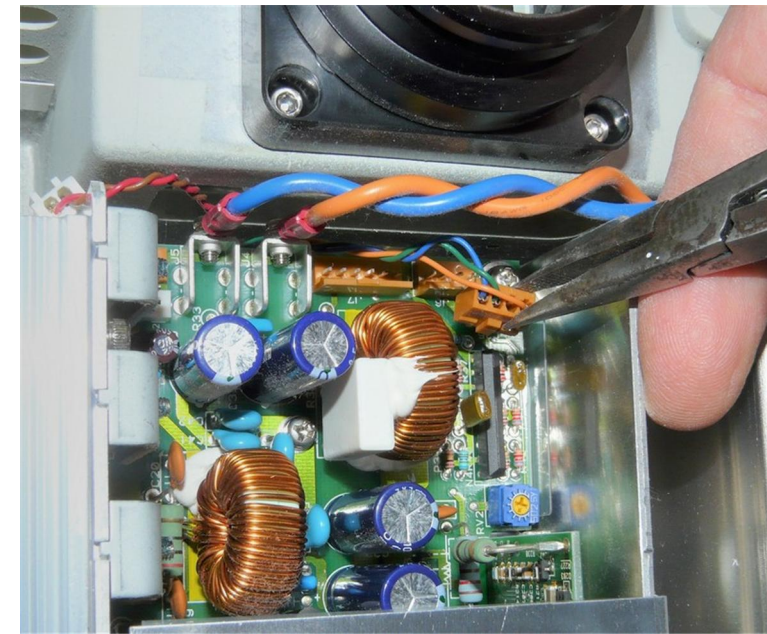

(5) Disconnect the orange, green and blue cable with the orange plug from the power supply.

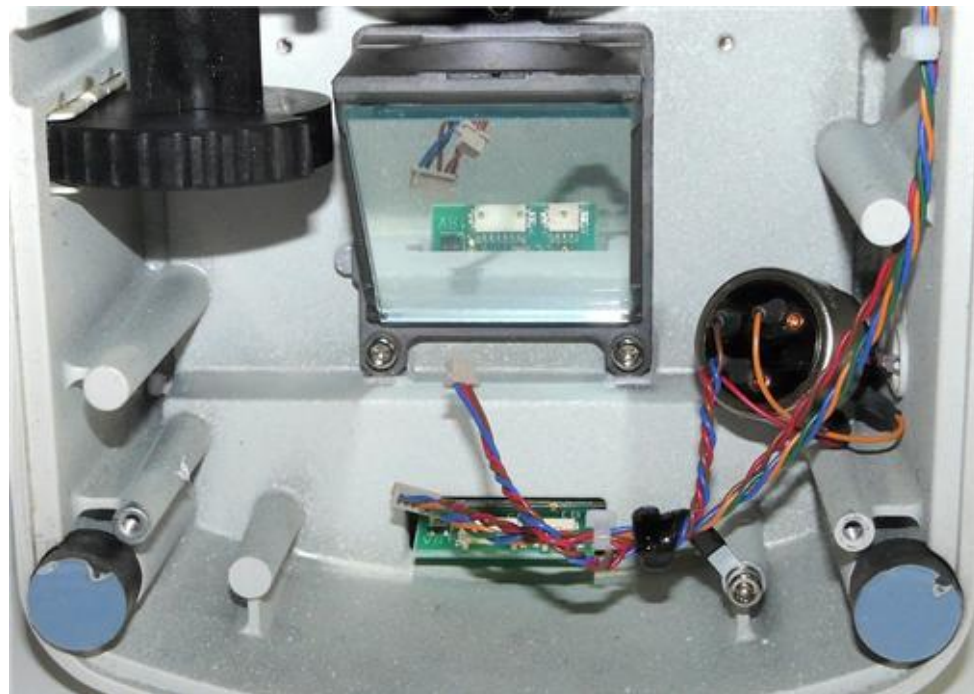

(2) Disconnect the two cables from the sockets on the green pcb. The pcb will not be used, but left in place for appearance.



(4) Disconnect the red and brown cable with the white plug from the power supply.

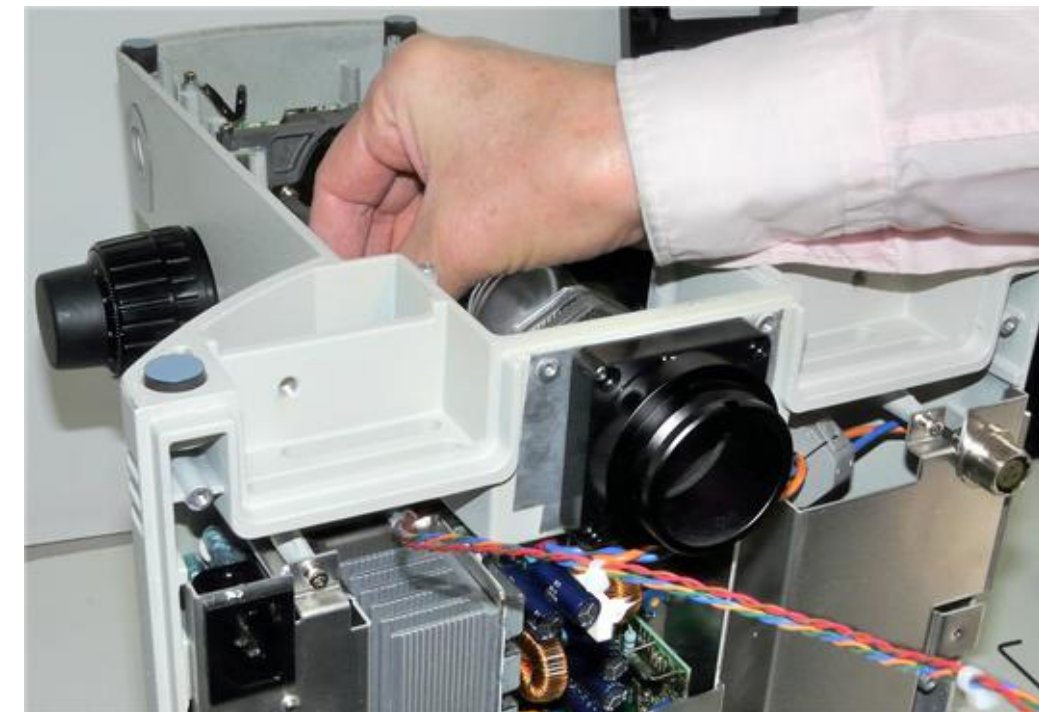

(6) Pull the disconnected cables out of the microscope. You will have to help feed the wires through from the inside.

Nanodyne Replacement Illuminator for Nikon 80i Installation Instructions: Step 3. Install Potentiometer for New Illuminator



(1) Do not remove the original illuminator mount. Nanodyne adapter will fit as is.

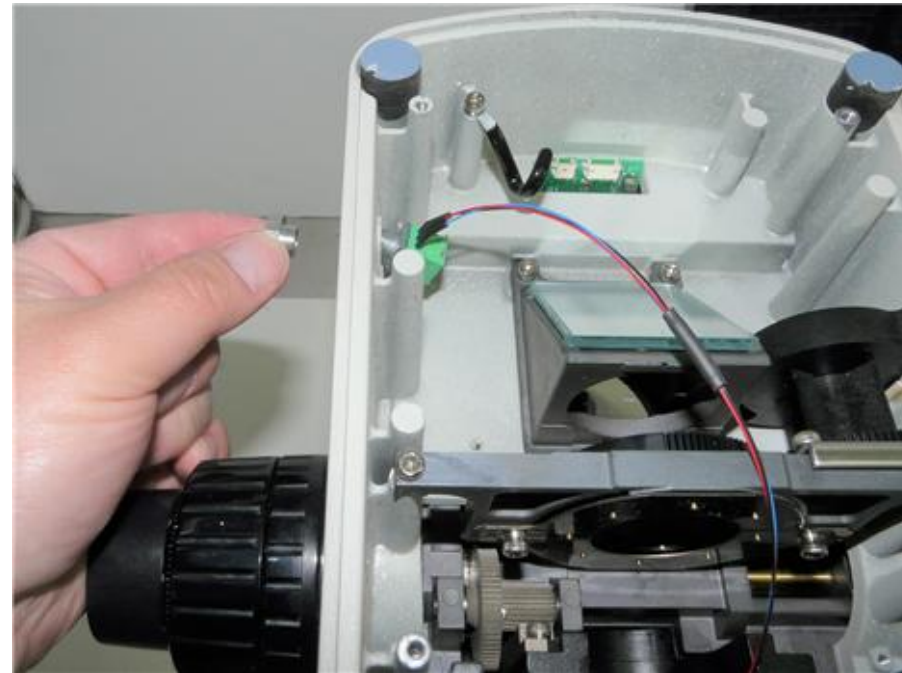

(2) Install the new pot using the PN 11119 custom nut to secure it to the microscope. Use a 7/16 inch socket to tighten it.

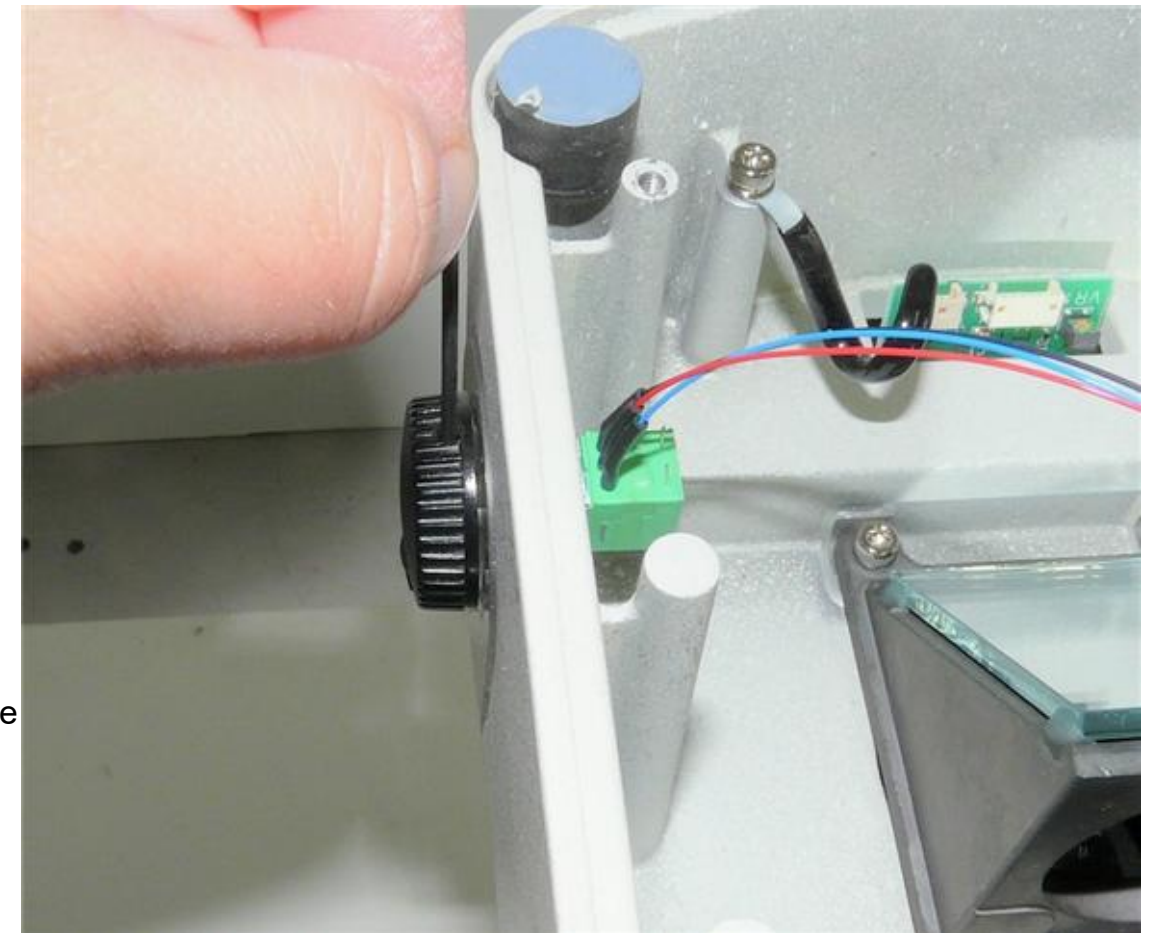

(3) Install the knob on the new pot using the 1.5mm hex key.

*Note: Do not remove OEM mount. Nanodyne updated adapter just slide onto the black OEM mount.

Nanodyne Replacement Illuminator for Nikon 80i Installation Instructions: Step 4. Route Pot Cable, Replace Back Cover, Install Illuminator

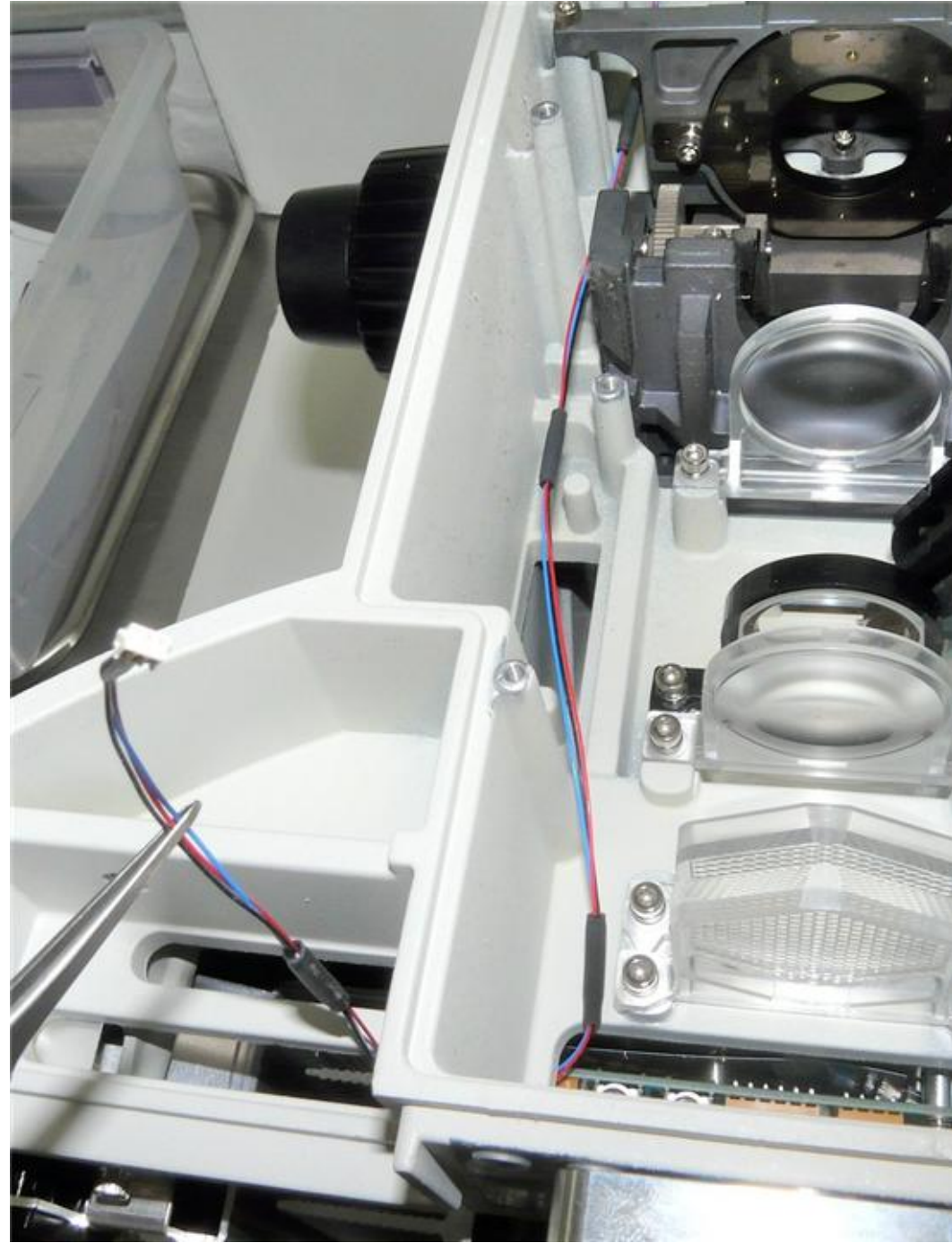

(1) Route the pot cable as shown above.



(2) Replace the back cover.

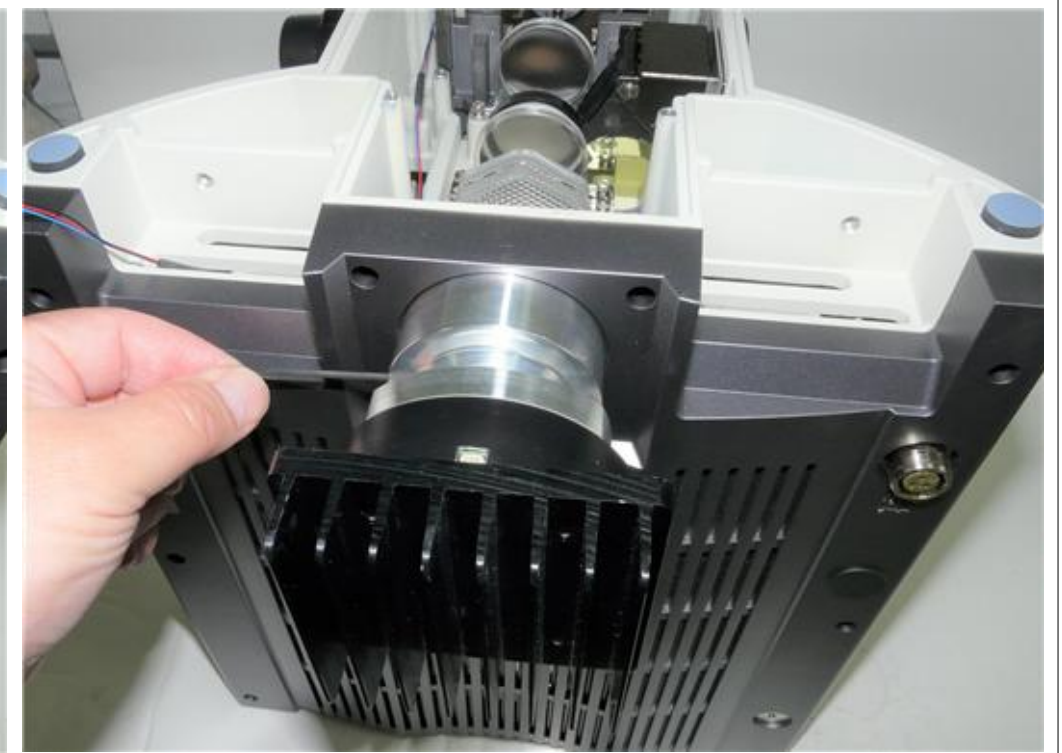

(3) Insert the new illuminator and tighten the set screw with the 2mm hex key.



(4) Connect the pot cable to the illuminator.

*Note: Photos show now-obsolete aluminum adapter. Nanodyne updated adapter just slide onto the black OEM mount.

Detailed pot cable connection procedure is shown on the next page (sheet 6).

Nanodyne Replacement Illuminator for Nikon 80i Installation Instructions: Step 4 (continued). Pot Cable Connection Details

Connect the plug at the end of the Pot Cable Assembly to the mating socket of the illuminator, as shown in the pictures on this page. NOTE THAT THE PLUG IS KEYED TO ONLY GO INTO THE SOCKET ONE WAY, AS SHOWN.

Partially insert the plug into the mating socket of the illuminator by holding the wire next to the plug with your finger (photo 2).

Use your fingernails, if you have them, or tools like a tiny screwdriver or tweezers pushing on the side of the plug to fully insert it (photo 3).

The socket cannot be fully engaged by pushing on the wires, as the wires would just collapse.

To disconnect it if needed, pull the wire straight out by firmly gripping the black heat shrink tubing.

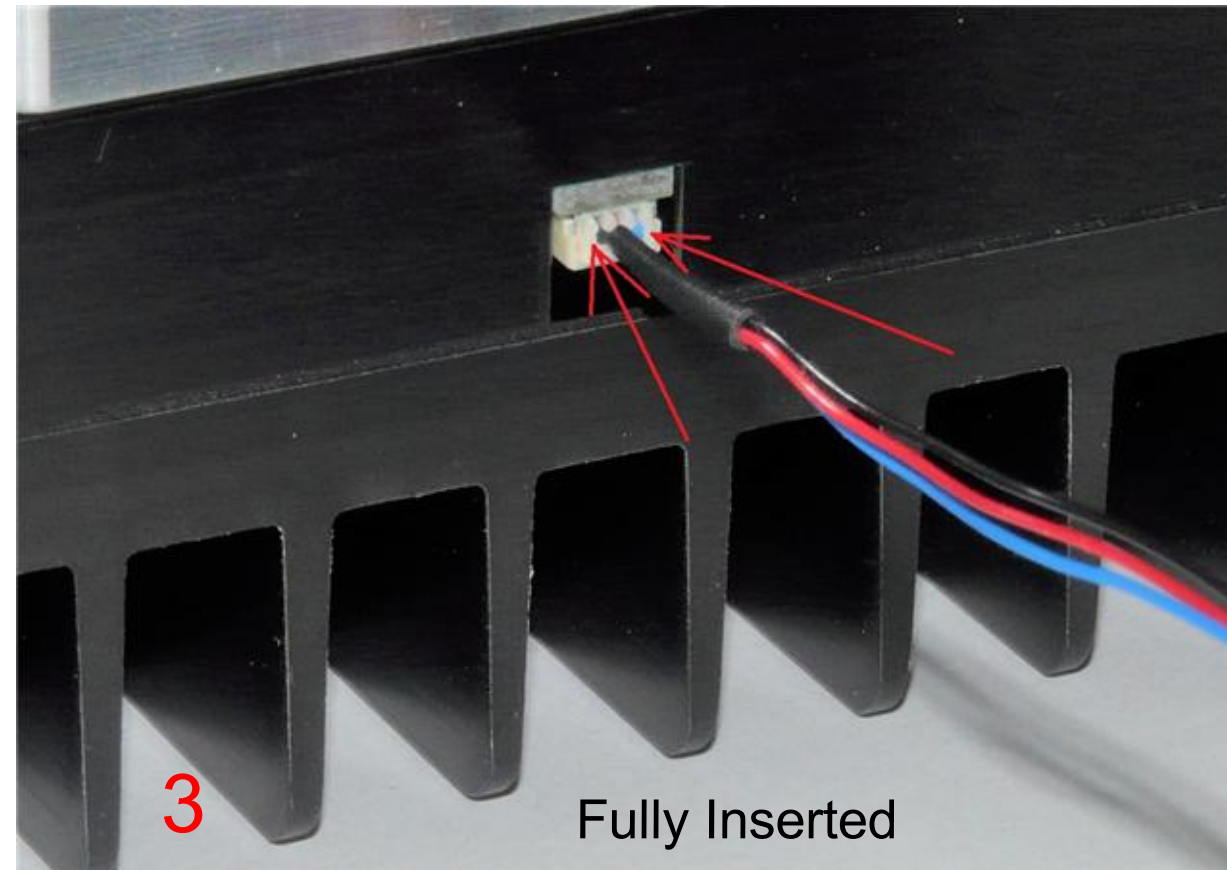
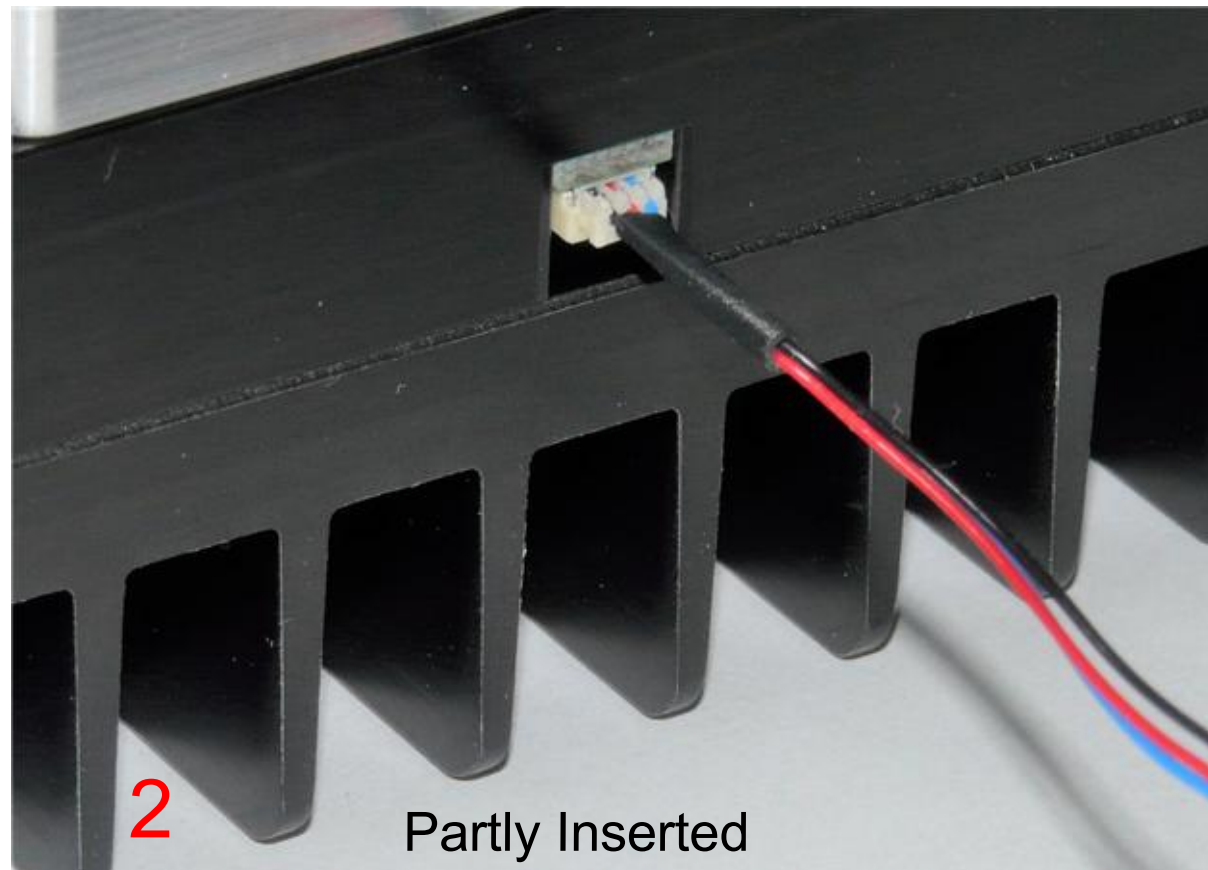
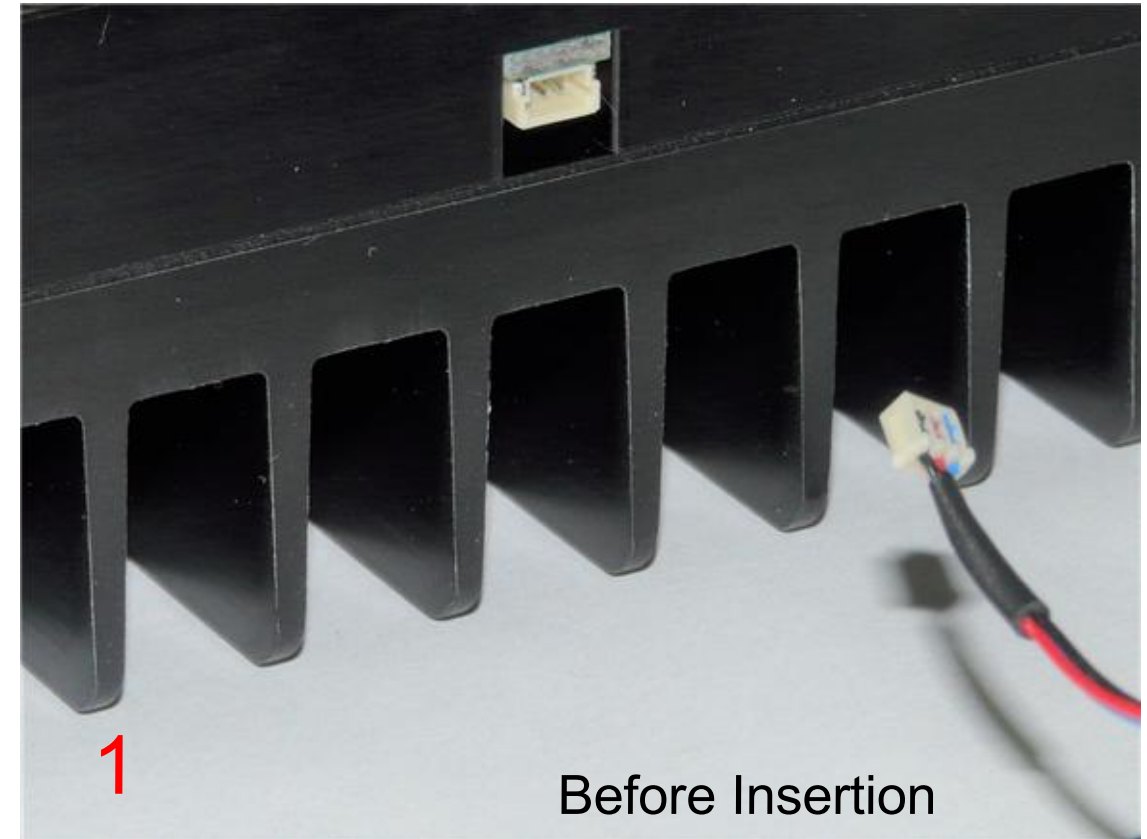

Nanodyne Replacement Illuminator for Nikon 80i Installation Instructions: Step 5. Secure Pot Cable, Replace Bottom Cover, Electrical Safety



(1) Secure the pot cable with the 3M VHB tape (red, in above photo). Secure it inside the microscope also, where the cable goes by the focusing gear.



(3) Attach the power supply cable and plug it the power supply. It now ready to operate.



(2) Install PN 10736 rubber blocking plug in the now-obsolete AC receptacle as shown in the photos.

Note that your illuminator and power cable will look slightly different (as shown on the first page). The installation procedure is the same.

Han-Seung Yang	5/19/2021
PN 11121 Nikon 80i Illuminator System Installation Instructions	REV 4
SHEET 7 OF 7	